

[the sylvanian]

spring 2015

Pennsylvania Chapter Sierra Club • pennsylvania.sierraclub.org

[the pipeline invasion] where will it end?

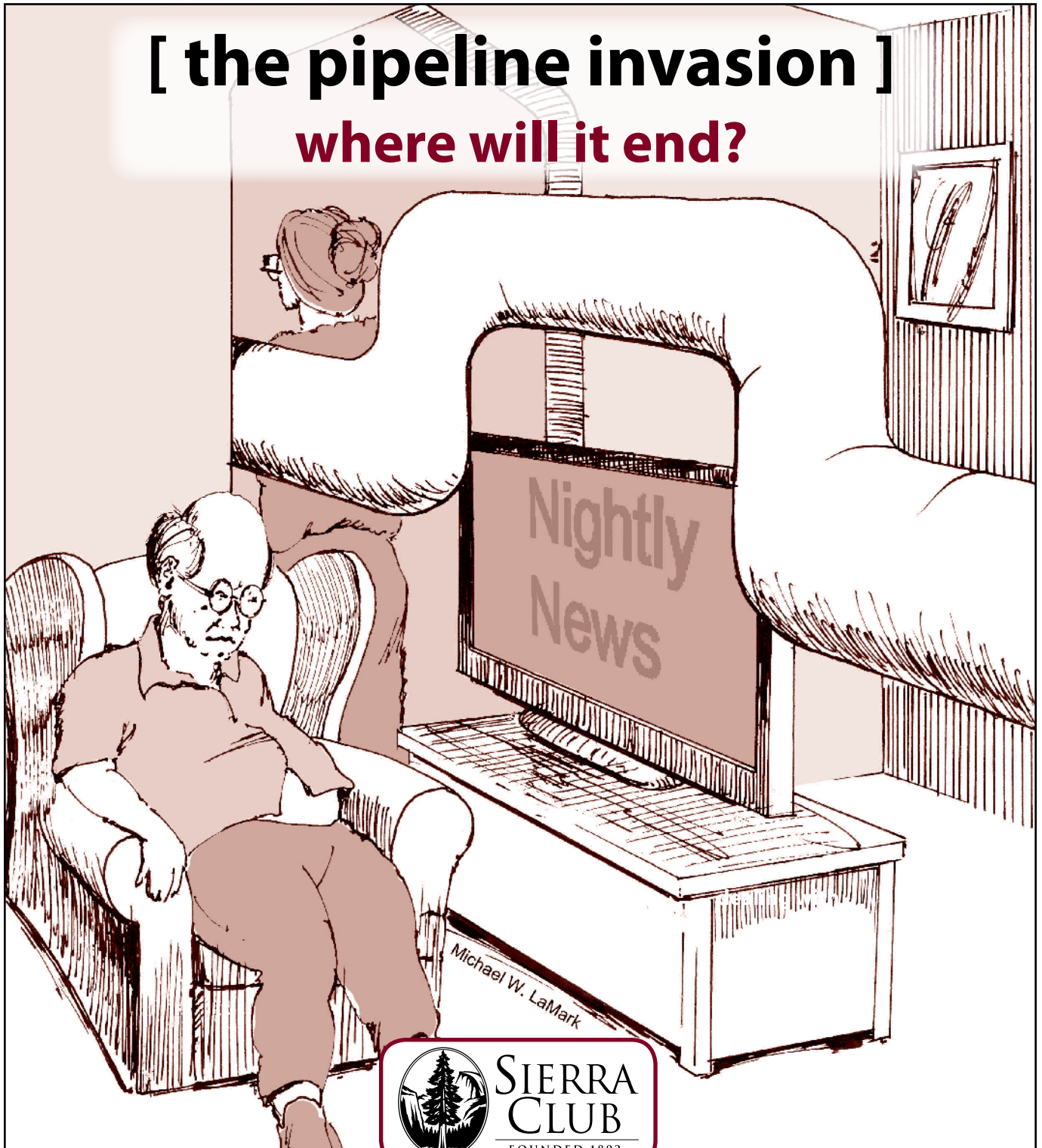

explore, enjoy and protect the planet.

[from the editors]

passionate about pipelines

More than any other issue, this edition of *The Sylvania* is filled with passion. At first, we tried to edit out the passion but then we realized it was almost impossible. People take these pipelines personally because they are going to affect their quality of life forever.

Intellectually, we knew the day would come when natural gas companies that were drilling thousands of wells would have to be connected by pipelines. People, who had never been impacted by the fracking before, now have the problems with natural gas brought to their doorsteps through pipelines and pumping stations. They don't like it.

As they see trees being cut down, farmland destroyed and historic places decimated by the natural gas industry, people are horrified. What seemed like a good idea in theory is awful in practice.

People thought that one of the many government agencies would protect them. They haven't. In fact people feel like their government has lined up to help the industry, rather than them. They feel let down by their government – local, state and federal.

Now people are rediscovering their neighbors and are deriving some power from people standing together. The gas industry has awakened a sleeping giant with their tactics. As folk singer, Anne Feeney, once wrote, "There are a whole lot more of us than they think."



Wendi Taylor



Phil Coleman

WENDI TAYLOR AND PHIL COLEMAN
Co-editors of *The Sylvania*



Read our Blog:
<http://sierraclubpa.blogspot.com/>



Find us on Facebook:
<http://www.facebook.com/PASierraClub>



Follow us on Twitter:
[@SierraClubPA](https://twitter.com/SierraClubPA)

DO YOU HAVE
SOMETHING ON YOUR MIND?



Consider this your invitation to say it on our blog. Yes, the Sierra Club Chapter has a blog that allows our members to share their thoughts, ideas and peevs with the rest of us on Sierra Keystone Conversations.

THE PROCESS IS SIMPLE.

Submit your blog to:
wendi.taylor@verizon.net

Or, of course, you can just be a regular reader. Find it at:
<http://sierraclubpa.blogspot.com/>

PENNSYLVANIA CHAPTER
OFFICE

Phone: 717-232-0101

Email:

pennsylvania.chapter@
sierraclub.org

Website:

www.pennsylvania.sierraclub.
org

Editors: Wendi Taylor &
Phil Coleman

Feature Writer: Gary Thornbloom

Design: Sydney Willis
Strategy Design Studio

The Sylvanian, © 2015 Sierra Club
Pennsylvania Chapter. Issued four times
per year.

This publication is dedicated to serving
the Sierra Club Pennsylvania membership,
and is a forum for internal policy
discussion and debate among those
truly concerned with protecting the
environment. Opinions expressed herein
are the personal opinions of their authors
and may or may not reflect Sierra Club
policy.

Contributor deadlines are June 15 (Summer
issue), September 15 (Fall issue), December
15 (Winter issue), and March 15 (Spring
issue). Anonymous contributions are not
accepted.

SIERRA CLUB MISSION STATEMENT:
To explore, enjoy and protect the wild
places of the earth; To practice and
promote the responsible use of the earth's
ecosystems and resources; To educate and
enlist humanity to protect and restore
the quality of the natural and human
environment; and To use all lawful means
to carry out these objectives.

Sierra Club's sexual harassment policy
can be found online at [http://mitchell.
sierraclub.org/leaders/policies/sexual-
harassment.asp](http://mitchell.sierraclub.org/leaders/policies/sexual-harassment.asp) or by contacting the
Harrisburg office.

PRINTED ON RECYCLED PAPER WITH SOY INKS



[the sylvanian]

[pipelineinvasion]

special report

- 7 Pipeline Proposals Creating Heartburn
- 8 Active Pennsylvania Pipeline Projects
- 10 The Great Infrastructure Build-out: Pennsylvania's Future, Fracking and Us
- 11 One Story of Resistance
- 12 Your Landowner Rights
- 13 A Foolish Trade-Off
- 14 Sunoco Plans a Pipeline Stretching Across Southern Pennsylvania
- 15 Proposed Pipeline Bisects Native American Sites

landmarks

- 2 From the Editors
- 4 View From Harrisburg
- 6 Coleman's Lantern
- 17 Explore, Enjoy... Pennsylvania
- 24 Crossword

news & outings

- 19 Meet Sue Edwards
- 20 Coal Mining Continues to Scar Pennsylvania
- 21 Wyona Coleman Scholarship
- 21 Huplits Wildlife Grant
- 22 Clean River Campaign
- 23 Meetings and Outings



[on the cover]

Michael LaMark uses a little homespun humor to demonstrate the feelings some property owners are feeling about being overwhelmed by pipelines. See our special section.

To send photos by email:
wendi.taylor@verizon.net or
pcoleman19@tampabay.rr.com

*To mail photos: Sylvanian, Sierra Club
- PA Chapter, PO Box 606, Harrisburg,
PA 17108*

next deadline: June 15

Send articles & photographs
to: wendi.taylor@verizon.net or
pcoleman19@tampabay.rr.com

chapter directory

Due to space restrictions, the Chapter Directory was not included in this issue. To view the directory, go to [http://pennsylvania.
sierraclub.org/PA_Chapter_2008/chapter-
directory.html](http://pennsylvania.sierraclub.org/PA_Chapter_2008/chapter-directory.html)

[the view from harrisburg]

by Joanne Kilgour, Chapter Director

GOVERNOR WOLF'S FIRST TRACKS: NOMINATION OF DEP AND DCNR SECRETARIES; EXECUTIVE ORDER TO PROTECT STATE PARKS AND FORESTS; 2015-2016 PROPOSED BUDGET; SUPPORT FOR MORATORIUM IN THE DELAWARE RIVER BASIN



When Tom Wolf was on the campaign trail, he gave the Pennsylvania Environmental Council a detailed overview on his plan for the environment, and in particular what actions he would take in his first 100 days. Sierra Club, and coalition partners have worked to keep environmental issues at the top of the Governor's policy agenda amid such competing issues as the Administration's first budget and confirma-

tion of executive nominees. Below is the progress we have seen so far, and perhaps some insight into what we can expect in the months to come.

Actions taken toward environmental agenda:

- **Appoint qualified individuals to lead the Department of Environmental Protection (DEP) and the Department of Conservation and Natural Resources (DCNR):** Governor Wolf nominated John Quigley as

Secretary of DEP and Cindy Dunn as Secretary of the DCNR. Dunn was most recently the President of PennFuture, prior to which she spent 12 years at DCNR and was a deputy secretary during the Rendell Administration. Quigley served as DCNR Secretary from 2009 to 2011, and has also worked in the nonprofit and private sector, serving as the Mayor of Hazelton and also working in government relations at PennFuture. Both Dunn and Quigley are qualified for their respective posts, and if confirmed will make effective, passionate leaders for their agencies.

- **Submit a budget that includes additional funding for DEP so that it is sufficiently staffed and able to provide oversight of natural gas drillers:** Proposed 2015-2016 budget includes a slight increase for DEP and could enable the agency to hire 50 additional oil and gas inspectors to help meet inspection obligations for natural gas development.
- **Bring greater transparency to the fracking process:** While there has not been movement yet toward greater transparency, the proposed budget includes funds for additional inspectors referenced above and also modest funds for a health study on the impacts of unconventional natural gas development on community health.

ISSUES YET TO BE ADDRESSED:

- Allow local communities more control in zoning.
- Take a three-pronged approach to abandoned mine drainage restoration: legislation, research and development of cost-effective strategies, and additional state and federal funding.
- Advance legislation to improve the Alternative Energy Portfolio Standard.
- Issue Responsible Climate Change Action Plans.

- Set Green Building Standards for State Buildings.
- Reduce Greenhouse Gas Emissions by joining the Regional Greenhouse Gas Initiative and using a portion of the revenue generated from the sale of permits to invest in renewable energy technology.

A WIN FOR PA PUBLIC LANDS: WOLF SIGNS EXECUTIVE ORDER TO PREVENT NEW LEASES FOR OIL AND GAS IN STATE PARKS AND FORESTS

Our state lands are cherished places where families gather to hike and camp, where children learn to fish, and where the value of the natural world is celebrated. In the last year of the Corbett Administration, these lands were exposed to the threat of additional natural gas development, but on January 29, 2015, Governor Wolf signed an executive order placing a moratorium on new leasing for oil and gas drilling in state parks and forests. This action reinstates a 2010 moratorium on new leases of state lands that was established after a review by the DCNR determined that no additional state forest acreage was suitable for natural gas development.

Through this executive action, Wolf upholds his duty as a public trustee to conserve and maintain these public natural resources.

Public lands protection is at the core of the Sierra Club's mission. Our members have tirelessly advocated to protect parks and forests from natural gas development; I hope you will share in this victory for present and future Pennsylvanians. This Spring I encourage those of you who are able to celebrate this act by getting out into one of our 120 state parks or 20 state forests – maybe we will even run into each other!

FACING A \$2.3 BILLION STRUCTURAL DEFICIT, GOVERNOR WOLF PROPOSES FIRST BUDGET; MAINTAINS SUPPORT FOR DRILLING MORATORIUM IN DELAWARE RIVER BASIN

On March 3, Governor Wolf announced his proposal for the 2015-2016 state budget. In his budget address, the Governor articulated the values of fairness, inclusion, and common sense. With the looming challenge of a \$2.3 billion structural deficit, the Governor has proposed a balanced budget that will help to reverse the trend of reducing funding necessary for environmental protection and conservation. The Governor also asserted that the gas industry has not paid its fair share, and companies need to be held accountable.

The Governor's proposal for DCNR's budget will enable all 120 state parks to remain open and will add 22 new state park employees. One of the Sierra Club's ongoing concerns with the DCNR budget has been use of Oil and Gas Lease Fund monies to support the general operations of the agency, rather than its stated purpose of supporting conservation, recreation, and flood control programs. Under Wolf's proposal, \$20 million of DCNR's operating budget would be funded through the General Fund, not the Oil and Gas Lease Fund, and DCNR's overall budget would increase by \$8.3 million. While this is just a start, it begins to put the agency back on the path toward carrying out its mission to maintain, improve and preserve state parks and state forest lands without depending on industry for operating support.

Governor Wolf is also proposing to restore funding for the Delaware River Basin Commission, with a 72.8 percent increase in General Fund monies over the appropriation from the 2014-2015 budget under Governor Corbett. In addition, Wolf has reiterated his support for maintaining the moratorium on unconventional drilling for natural gas in the Delaware River Basin.

We agree with Governor Wolf that "not long ago, we were one of the top wind and solar-producing states in the country, using the green economy to create jobs. But we took our eye off the ball and fell behind." It is encouraging to see the Governor propose to restore funding for the PA Sunshine Solar Program in the amount of \$50 million, while also proposing \$50 million for projects to improve energy efficiency at small businesses, local government units, schools and non-profits.

While there are many elements of the Governor's proposed budget that we support, several of those provisions have been met with significant scrutiny by members of the General Assembly. Our State Senators and State Representatives will play a key role in determining which elements of the proposed budget move forward, and I urge each of you to contact your elected officials to ask them to support the budget provisions that will enable the Commonwealth to hold drillers accountable and make them pay their fair share, and to take advantage of the economic opportunity presented by renewable energy and energy efficiency.

UNDER NEW ADMINISTRATION, DEPARTMENT OF ENVIRONMENTAL PROTECTION RELEASES DRAFT OF FINAL OIL AND GAS REGULATIONS, REORGANIZES OIL AND GAS TECHNICAL ADVISORY BOARD

One year ago, in March of 2014, the Sierra Club was among the 24,000 individuals and organizations that submitted comments on proposed revisions to state oil and gas regulations, referred to as "Chapter 78." The Pennsylvania DEP recently released its updated draft of these regulations, which reflects many of the changes Sierra Club members and its coalition partners worked to achieve.

While not perfect, these draft regulations reflect an impressive attention to detail and responsiveness to public comments. It is important to secure the best protections from oil and gas operations, recog-

nizing that we will continue to advocate for measures to preserve the environment and promote public health. In its current proposal, DEP addressed many of the issues raised in our technical comments, and even included a provision on noise pollution. These changes include:

- Requiring operators to demonstrate that streams and wetlands will be protected if the edge of the well pad rather than the wellhead is within 100 feet of the resource;
- Requiring existing centralized wastewater impoundments to be upgraded or closed within three (3) years of the effective date of the final regulations, and for centralized wastewater impoundments to be permitted through the Residual Waste Program;
- Expanding the review of impacts that operators must conduct to include public resources, such as schools, playgrounds and approved wellhead protection areas;
- Requiring operators to identify active, inactive, orphan and abandoned wells and submit a plan report to DEP at least 30 days prior to drilling;
- Creating standards for noise control and mitigation; and
- Prohibiting the use of onsite reserve or storage pits; and
- Requiring water supplies to be restored to either pre-drilling or Safe Drinking Water Act standards, whichever is better.

Due to the potential impact on human health and the environment from hazardous pollutants associated with these centralized impoundments, we remain concerned that under DEP's proposal, it may take more than three years before open storage of waste is eliminated.

We plan to submit technical comments on this proposal, and we encourage each of you to submit comments if you have specific areas of concern.

[coleman's lantern]

the corners of the earth

by Phil Coleman

Isaiah 11:12 -- "And he shall set up an ensign for the nations, and shall assemble the outcasts of Israel, and gather together the dispersed of Judah from the four corners of the earth."

When Israelites discussed the four corners of the earth three thousand years ago, it didn't matter that the earth doesn't have corners. How could it matter when their means of transport was a donkey at best and they knew they would never travel to any one of the corners? If they had known the earth was round, they still would have lived their lives as though it was flat. And today in our ordinary affairs we live on a flat earth.

Of course, it does matter when we fly at a speed considerably faster than a Jack-ass trot. And it matters that Columbus believed the world round and opened up a pair of continents, one on which we live.

But consider all else we know. We know the solar system. We know our Galaxy. We have read about, even if we don't know (or understand), the extent of the universe and we say we know that it began in a BIG BANG almost FOURTEEN BILLION years ago.

We did read, and tried to understand that TIME might not be one directional or one dimensional. Now quantum theory, which the bulk of us only read about and truly do not understand, posits the possibility that there are an infinite number of universes in the MULTIVERSE,

all existing at the same time -- although time, too, is infinitely extensive.

No experiment has been devised to demonstrate existence of anything beyond what our most powerful telescopes and accelerators have observed, and they haven't quite observed the BIG BANG yet -- and not really the God particle or Higgs Boson. But the math logic of quantum theory is a powerful tool.

Meanwhile, we live our lives for the most part on a flat earth, only occasionally living on a globe. We stare at the sky and see the sun "rise" and "set." Only when we put our minds to it do we remember that Earth is a whirling dervish held captive by the sun.

Does it bother anyone that when I moved "down" South, the "down" was just a direction on a paper map? Does it matter to anyone that Google -- the epitome of modern technology -- uses a Mercator-like projection that distorts

measurements to make us know we live on a flat earth? In fact, it gives us a map that almost shows the earth with four corners. It can do that because our burro will never take us to either pole.

We will still live flat earth style five years from now when everyone under 35 has a cell phone implanted in her head. No one will worry about driving distractions because cars will drive themselves. But swimmers will listen to their favorite tunes between chats and tweets, even under water. Facebook will no longer show ads: it will just deliver the things it knows I want and will charge me by PayPal automatically. If you have a Big Mac attack, your car will automatically find the closest Mac Donald's and drive in.

Even so, we will be flat earth people, letting our asses carry us wherever we want to go -- as long as we don't want to transcend the four corners.

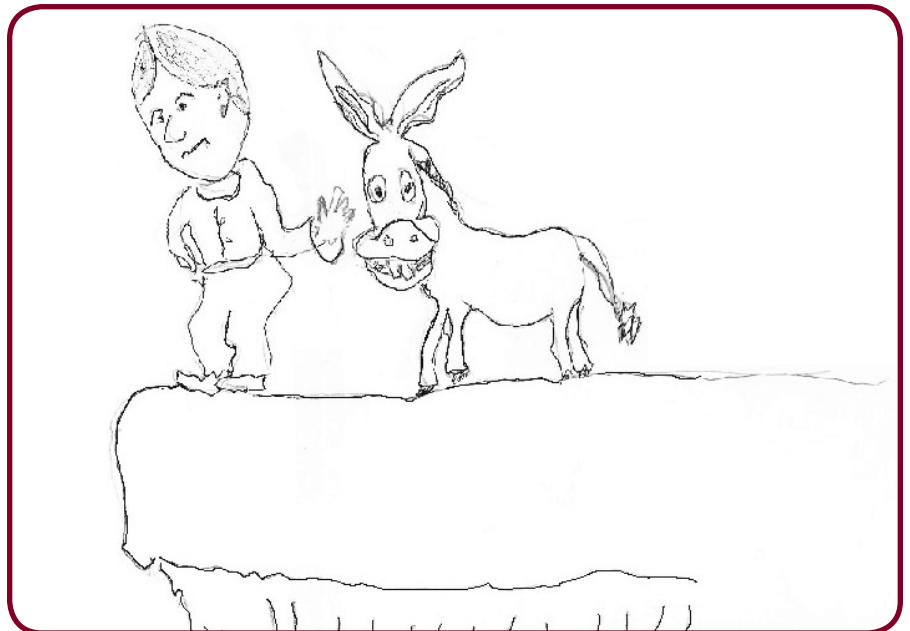

Sylvanian Sam finds one of the four corners. His companion shows great interest.

intro to special section

by Wendi Taylor

Apologists for gas fracking are fond of mentioning all real and imagined, direct and indirect benefits of gas. But they ignore the negatives. **Hundreds, actually thousands, of miles of gas lines will be foisted on Pennsylvanians**, many times without private owners' permission. We examine that problem in the following pages.

pipeline proposals creating heartburn

by Wendi Taylor

For the first time, people who never experienced the consequences of Marcellus Shale drilling, are weighing its benefits and drawbacks in a new way – personally. The proliferation of pipeline proposals throughout Pennsylvania is creating heartburn for many people who until now were untouched by natural gas boom.

The proposals are coming so fast, it is difficult to keep track of them. The magnitude of these proposals has caught the attention of John Quigley, Acting Secretary of the Department of Environmental Protection (DEP). While DEP does not have a major role in siting or regulating of these pipelines, Quigley recognizes that construction of so many pipelines -- requiring right of ways, pumping stations and valve and compressor stations -- could change the landscape of Pennsylvania. He has asked Denise Brinley, DEP's Deputy Secretary of Programs, to bring together the interested parties to try to devise a rational plan.

Quigley is hoping that with some guidance and conversation, the parties can find a mutually agreed to plan to minimize environmental damage, while allowing companies to move their products to market. "We're not under any illusion to reduce impact to zero," Quigley said. "There's going to be impact but are there opportunities to plan smarter?" He thinks it is worth exploring, even though participation in these discussions would be voluntary.

In some instances, energy companies have rights of way that were purchased in the 1930's before there were zoning laws and before the development of suburbs. Rights of way that were far from people 85 year ago, now run through communities. In some instances, companies are seeking to widen rights of way which encroach on neighborhoods. Many local governments have gone on record opposing the proposed pipeline routes.

Signing a right-of-way (ROW) agreement can have an effect on owners' income taxes and property taxes, their insurance, the value of their property, their mortgage agreements, and the ability to refinance or develop the property. Further, once a ROW has been established, it becomes much easier for pipeline companies to expand the size of the right of way.

As communities begin to feel the effects of an expanding system, many are asking how safe pipelines are.

Pipeline companies are required to calculate the potential impact radius (PIR) — the circle in which the potential failure of a gas pipeline could have a significant impact on people or property — as established by the U.S. Department of Transportation's Hazardous Materials Safety Administration (PHMSA). PIR is determined by a formula which considers the

continued on page 16

[pipeline invasion]

[special report] articles

- Pipeline Proposals Creating Heartburn.....7
- Active Pennsylvania Pipeline Projects.....8
- The Great Infrastructure Build-out: Pennsylvania's Future, Fracking and Us..... 10
- One Story of Resistance 11
- Your Landowner Rights..... 12
- A Foolish Trade-Off 13
- Sunoco Plans a Pipeline Stretching Across Southern Pennsylvania 14
- Proposed Pipeline Bisects Native American Sites..... 15

[the sylvanian]

spring 2015 Pennsylvania Chapter Sierra Club - pennsylvania.sierraclub.org

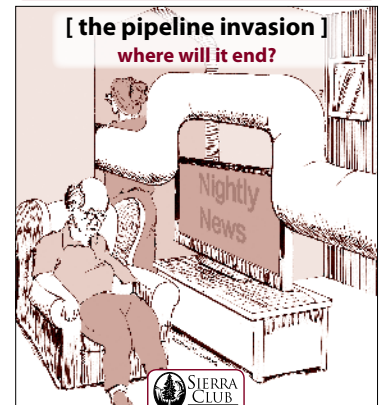

watch, enjoy and protect the planet.

[pipelineinvasion]

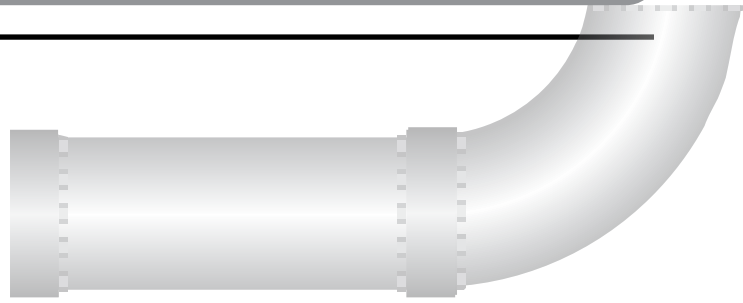

active pennsylvania pipeline projects

ATLANTIC SUNRISE PIPELINE

Williams Partners is proposing to install a 42-inch natural gas pipeline from the natural gas fields in northern Pennsylvania, to stretch 178 miles through the counties of Susquehanna, Wyoming, Luzerne, Schuylkill, Lebanon to Lancaster, and through the more western counties Clinton, Lycoming, Columbia, and Northumberland. The Atlantic Sunrise Pipeline will hook up to the existing Williams Transco pipeline in Lancaster County. If the project is completed, Williams estimated the pipeline system will carry 1.7 billion cubic feet of natural gas each day on its way to Cove Point, where the industry hopes to liquefy the natural gas and export it.

Several municipalities (Annville, Conestoga, Dallas Township, Eldred Township, Harveys Lake, Lancaster, Martic, Pine Grove Township, and South Londonderry) have passed resolutions opposing the Atlantic Sunrise Pipeline.

Williams just filed its official application with the Federal Energy Regulatory Commission (FERC). People have 20 days to register as an intervener to participate in the proceedings.

CONSTITUTION PIPELINE

The Constitution Pipeline is a \$700 million joint venture among Williams Companies, Cabot Oil & Gas Corp., Piedmont Natural Gas Co. and WGL Holdings, which is constructing 126-mile pipeline from Susquehanna County, PA, to Schoharie County, NY. The 30-inch pipeline is projected to carry about 650 million cubic feet of gas each day to markets in New York

and New England. The project includes two compressor stations with provisions for more.

In December, the Federal Energy Regulatory Commission (FERC) approved the Constitution pipeline. Upon approval, the project was granted the power of eminent domain to acquire easements on properties on the pipeline route, as provided by the Natural Gas Act. The company has acquired all but a handful of the 130 parcels necessary to build the pipeline.

DIAMOND EAST PIPELINE

The Diamond East Pipeline will follow a parallel path to the existing Transco and proposed PennEast pipelines from Luzerne County, PA to Mercer County, NJ. It calls for additional compressor stations and loop segments along the existing Transco corridor.

Diamond East is subject to approval by the Federal Energy Regulatory Commission and other agencies. The project comes in addition to the \$3.3 billion in capital expenditures planned through 2017 on Transco growth projects designed to serve markets in the Northeast, according to Williams.

MARC-II PIPELINE

Central New York Oil and Gas Company is proposing to construct a 39-mile natural gas pipeline that would run through three Pennsylvania counties, Bradford, Sullivan and Lycoming. It would be a new interconnect on Transco's Leidy Line, and Transco's proposed Atlantic Sunrise Expansion project in Dallas, Luzerne County.

The proposed route would cross high quality streams in the Endless Mountains and disturb about 610 acres and permanently alter 238 acres. The MARC-II is subject to approval by the Federal Energy Regulatory Commission and other agencies. The company hopes to have MARC-II Pipeline in service by the end of 2017.

MARINER EAST I

Mariner East 1 Pipeline is an existing 350-mile, 8-inch pipeline, which Sunoco Logistics is "repurposing" to move natural gas liquids from western Pennsylvania across southern Pennsylvania. Mariner 1 was built originally in 1931 -- making it older than 93 percent of all natural gas pipelines in the United States -- to ship gasoline from the company's refinery in Marcus Hook to western Pennsylvania. By reversing the flow in the 84-year-old pipeline and adding pressure, Sunoco hopes to transport up to 70,000 barrels per day (equivalent to 2.9 million gallons a day) of natural gas liquids (NGL) known as "wet gas," from the Marcellus Shale region in western PA to the company's Marcus Hook distribution facility along the Delaware River, near Philadelphia.

This project will add about 50 miles of new 12-inch pipeline in western Pennsylvania from Houston, PA to Delmont, PA, and then connect with about 300 miles of old pipeline from Delmont to the Marcus Hook refinery.

NGLs are products of shale gas hydraulic fracturing. At normal pressure and temperature the products are gases, but under pressure become liquids. It will require 18 new pumping stations to pressurize the natural

gas liquids and vent the pipeline and 17 new valve control stations, which are used to shutoff the pipeline in an emergency. Pumping stations spaced out every 17 miles.

In September, the Pipeline and Hazardous Materials Safety Administration, which inspects the Mariner 1 pipeline, cautioned the industry that pipelines may be compromised anytime the owner changes the flow, changes the pressure or changes the product. Sunoco is proposing to do all three.

Mariner East I would transport ethane and propane at up 1,200 to 1,500 per square inch of pressure. Sunoco will not add a chemical to produce odor to the ethane because it is used to make plastics and the product would pick up the odor.

MARINER EAST 2

Sunoco Logistics is also proposing to build the Mariner East 2 Pipeline, a new 24-inch underground line, to run mostly parallel to the company's existing Mariner East 1. This \$2.5 billion project will have the capacity to transport an additional 275,000 barrels per day of natural gas liquids (NGL) (ethane, propane and butane). NGLs are odorless, tasteless and colorless. Both ethane and propane are highly flammable and can result in fires and explosions if there are leaks.

In order to complete this project, Sunoco is seeking to expand its rights of way and has been holding informational meetings in communities across the lower half of Pennsylvania for affected landowners, municipal officials and other interested parties.

Mariner 2 will add an estimated 4-fold increase to Sunoco's NGL pipeline

transportation capabilities in Pennsylvania.

PENNEAST PIPELINE

PennEast Pipeline Partners, which is planning to build a \$1 billion natural gas pipeline about 100 miles long from Luzerne County through Pennsylvania to Trenton, NJ where connections to the Williams Transco, and Spectra's Algonquin Pipelines are located.

About 27 municipalities along the path of the proposed pipeline have passed resolutions opposing PennEast. Further, about 1,000 people attended the six public hearings, held by the Federal Energy Regulatory Commission (FERC) which is reviewing the project. The public has raised concerns about the pipeline's route and how it will affect abandoned coal mines, flood control systems, and sanitary sewage systems.

FERC ordered an environmental impact study, which was conducted by Drexel University.

SUNBURY PIPELINE

UGI Energy Services, LLC plans to build a 35-mile interstate 20-inch transmission line, which will provide natural gas to a power plant at Shamokin Dam. The \$160 million project would begin in Lycoming County and end in Snyder County, where the retired coal-fired power plant in Sunbury is expected to be replaced by natural gas plant, generating 1,000-megawatt of power, known as the "Hummel Station" power plant.

UGI hopes to get approval from the Federal Energy Regulatory Commission (FERC) in time to be in service by early 2017. The steel pipeline will be

designed to transport 200,000 dekatherms per day of natural gas.

PIPELINE OPPOSITION ADVOCATES:

Sierra Club PA Chapter - Joanne Kilgour - pennsylvania.chapter@sierraclub.org

Berks Gas Truth - Karen Feridun - <http://www.gastruth.org>

Pipeline Safety Coalition - Lynda Farrell - <http://www.pscoalition.org/>

Delaware Riverkeeper - Maya vanRossum - <http://www.delawariverkeeper.org/>

Gas Drilling Awareness Coalition of Luzerne County - <http://www.gdacoalition.org/>

Lancaster Against Pipelines - <http://lancasteragainstpipelines.com/>

Schuylkill Pipeline Awareness - schuylkillconcernedresidents@gmail.com

Stop PennEast Pipeline - <http://www.stoppenneast.org/>

Cumberland and Perry County Pipeline Awareness - cappipeline@gmail.com

Concerned Citizens of Lebanon County - Concernedcitizenslebc@gmail.com

Beyond Extreme Energy (BXE) <http://beyondextremeenergy.org/>

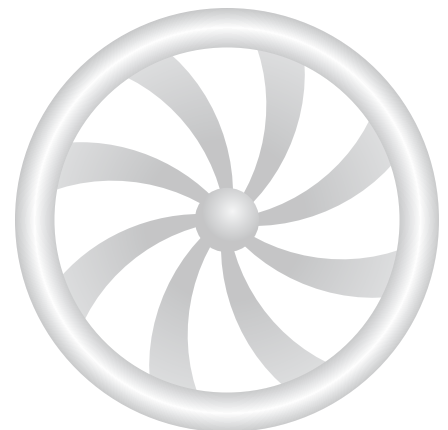

[pipelineinvasion]

the great infrastructure build-out: pennsylvania's future, fracking and us

by Robert Gardner, *Beyond Natural Gas Campaign*

*“Sentiment
without action
is the ruin of the
soul.”*

– Edward Abbey

As I write, work has just begun on the Easton, PA compressor station. Rumbling south towards Philadelphia and West through Pittsburgh, dangerous bomb trains are making their way through the Commonwealth. Days ago, Williams Partners broke ground on the Atlantic Sunrise pipeline project through Lancaster. With permit after permit comes the transition of our electricity generation towards greater reliance on new natural gas power plants.

Pennsylvania is in the midst of an infrastructure build-out that is being determined by cold, hard economics. As shale gas prices drop, operators are doing everything they can to build more flexibility into their operating model. That means options – specifically, options in where they sell their product.

The natural gas industry took advantage of a business opportunity here in Pennsylvania, giving our friends in Maryland and New York an example of why their states needed moratoria on fracking. They worked hard on their fights – but they are still going to use our gas. In my eyes, it looks like Pennsylvania is lined up to be a resource colony sending natu-

ral gas to the rest of the world while we have to deal with the enormous amounts of pollution that extreme extraction creates.

Make no mistake – fracking is dirty and dangerous and has plainly run amok throughout Pennsylvania. That is why the Chapter has called for a moratorium on any further drilling, whether it's in state parks, the Delaware Basin, or on private lands.

So, what's going on?

According to a new report by the Energy Information Agency (EIA), production of fracked gas will increase, and as a result, natural gas pipelines will cut through our state to push gas to the Northeast, Gulf Coast and the Atlantic Coast (including to the notorious planned export facility at Cove Point). There are no less than fifty-one major pipeline and infrastructure projects in various stages of development or permitting, to move gas from the Marcellus/Utica region. That is a nightmare for Pennsylvania. These projects include new and expanded bi-directional compressor stations (shifting import into Pennsylvania to export from Pennsylvania), new and expanded pipelines, reversals of pipeline flow, and a whole host of other projects (like intrastate pipelines to natural gas power plants, natural gas liquid lines, etc.).

Fracking was never really about Pennsylvania. It wasn't about our communities. Shale gas is a commodity. It is promoted as American energy independence, but the facts don't bear that out. Fracking is about money: plain and simple.

If the shale was in another state, they'd frack there. It happens to be in Pennsylvania. Call it what you will, but Pennsylvania is becoming a resource colony.

For those of us that do not live in the shale fields, we need to know that we are part of this struggle. The plan is to move natural gas and natural gas liquids from the Marcellus to the most lucrative markets – New England's houses, Southeastern power companies, Philadelphia's gas hub, or international Liquefied Natural Gas (LNG) exports – and to do so according to industry's timeline. Regardless of where you live, you are affected by this development.

The people of Pennsylvania should not have forgotten the lessons of history. First, exploiters came for the timber and they clear cut most of the state. Second, they came for the coal and they still won't admit or pay for the enormous damage they have done. Then they came for the oil. They drilled and left behind over three hundred and fifty thousand wells. Now, they want the fracked gas. They want the extreme kind: extraction requires miles of pipes and millions of gallons of water.

Where were those who learned these lessons? Will they help us now?

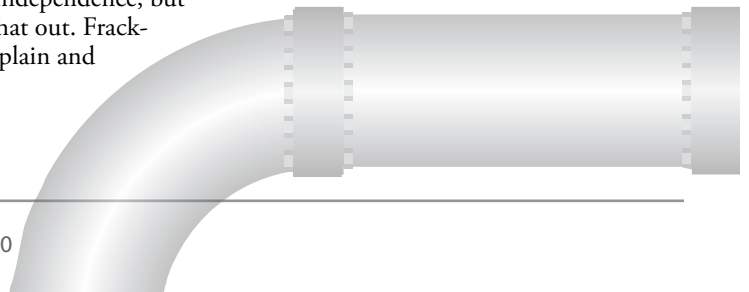

one story of resistance

by Malinda Harnish Clatterbuck

I have a story to tell that I wouldn't have believed a year ago. It begins with a man knocking on my door, asking permission to survey my property for the natural gas pipeline that was "coming through." At the time, I knew very little about fracking or natural gas pipelines. Twelve months later that has all changed.

I live on an eight-acre plot of land, where I was raised. After the death of my father ten years ago I returned to the land where the pristine Tucquan Creek runs through it. The property is an island surrounded by Lancaster County Conservancy - which I thought would protect it from industrial projects - and not a place for a 42-inch, high pressure pipeline.

The Atlantic Sunrise Project is a Williams Partners initiative to move natural gas fracked in the Marcellus Shale region of Pennsylvania to the eastern seaboard markets, including export facilities.

If the Federal Energy Regulatory Commission (FERC), which permits and regulates interstate pipelines, gives permission for this project, it would allow Williams to put this transmission line across my land without my permission and with NO benefit to me, and at great profit for a private corporation. How is this possible in America today?

The gas boom in Pennsylvania is threatening our rural way of life. Where I live, in southern Lancaster County, this transmission line is slated to cut through our woods, our preserved farms, sacred areas where Native American artifacts

rest, the farms of our Amish neighbors, and the yards of hard working Americans who have put all of their money into their own plots of land. And let me be clear—none of the natural gas running through this line would go to Lancastrians or Pennsylvanians (and there are questions of how much would even go to Americans).

As we became more aware of how the system works, many of us decided to resist. The strongest collective resistance is in Conestoga and Martic Townships. We have researched and educated ourselves so that hundreds of neighbors in our community can tick off the details of environmental damage of the gas industry; the millions of gallons of fresh water poisoned through the fracking process; the chemicals that are pushed into the earth; the trees that are cut down; the habitats that have been disturbed, divided, destroyed; and the potential time bombs planted outside our doors with high-pressure transmission lines reaching across our land.

We organized. Resistance groups have popped up all along the proposed line here: Lebanon Pipeline Awareness, Lancaster Against Pipelines, Martic SOUL (Save Our Unspoiled Land), Conestoga Community Group, Hempfield Environment Land and People. We have become community organizers who work voluntarily to try to stop the intrusion of the gas industry into our lives. Through home meetings and town hall meetings, mailings and conversations with neighbors, friends and elected officials, we share our stories and seek allies.

As the law stands now, if FERC gives permission for this project, Williams will be granted the right of eminent domain to condemn our properties. A few board members who run a large corporation in Tulsa, Oklahoma, would have more control over what happens in our little municipality than the people who live here and pay taxes here. The landowners here carry all of the risks of the transmission line and bear the brunt of the damage and limitations to their properties. We face decreased property value, loss of wooded space in the permanent 50-foot right of way, limitations of future subdivisions and the negative effects on raising crops. A private company is being given the right to do whatever it wants to do with our land with the endorsement of our government for the company's own private gain. We want to challenge this upside down system.

Since those we elected are not going to protect us, we are stepping up to use the laws to protect our land and our rights ourselves.

We are currently working toward Home Rule governance in Conestoga and Martic Townships. With the help of lawyers of the Community Environmental Legal Defense Fund (CELDF), we crafted language to establish energy sustainability in our home rule charters, prohibiting unwanted corporate exploitation within our community boundaries. The Pennsylvania Constitution gives us the right to do this under the Environmental Rights Amendment and we are doing it.

[pipelineinvasion]

your landowner rights when the pipeline man comes

by Donald Miles, Sierra Club Lehigh Valley Group

The natural gas industry is proposing new pipelines all over Pennsylvania.

What should you do if a representative from a natural gas pipeline company knocks on your door claiming that a pipeline is coming through your land?

Key Points:

1. Pipelines are NOT "done deals." Companies have many legal hoops to jump through.
2. You do NOT have to talk to agents or let pipeline surveyors or agents onto your land.
3. Do NOT sign ANY papers given you by the pipeline until you've consulted a lawyer.

Where to start: Determine which agency is regulating the pipeline

Natural gas pipeline construction is regulated -- by the Federal Energy Regulatory Commission (FERC) and (somewhat) by Pennsylvania DEP for interstate pipelines and (sometimes) by Pennsylvania Public Utility Commission (PUC) and DEP for pipelines within PA -- and both FERC and PUC usually approve a pipeline.

Pipeline projects which do not have FERC or PUC construction approval cannot exercise the power of eminent domain. In such instances, landowners should not be misled by representations that if they do not agree to a deal, the pipeline company can go to court to take their land.

Conversely, pipeline projects which have FERC or PUC construction approval can exercise the power of eminent domain.

Natural gas pipelines for which construction approval is not required by either the FERC or the PUC include gas gathering lines from well pads and gas pipelines which do not serve Pennsylvania consumers.

What Landowners on the Route of a Pipeline Should Do

Landowners and members of the community have some control over pipelines if they use it. Sometimes a pipeline company abandons its proposal or changes its route due to intense citizen opposition.

1. Contact your neighbors who are also on the pipeline route and meet with a pipeline opposition advocate.
2. If it is an interstate pipeline, you and your neighbors should go online to FERC, see: <http://www.ferc.gov/docs-filing/eregistration.asp>
3. If it is a pipeline entirely within Pennsylvania, its construction is sometimes, but not always, regulated by the Pennsylvania Public Utility Commission (PUC). The PUC

has to approve any pipeline that serves consumers directly. To find out if the project is subject to PUC approval, see: http://www.puc.state.pa.us/about_puc/search_results.aspx?advanced=true

4. If construction approval is required, file comments with FERC or PUC (as a group) arguing all your objections (pipeline not necessary or unsafe, another route better, route requested has environmental dangers, etc.).
5. For an interstate pipeline, when the pipeline formal Application is filed with FERC, go online to FERC to file an Intervention.
6. Gather all the information you can on the pipeline (FERC or PUC website, your municipality and county) and if an interstate pipeline ask FERC for site visits/meetings near you, propose other routes.
7. Go to the public meetings and forcefully state your objections to the pipeline.
8. Work with environmental groups in their joint effort to oppose the pipeline.
9. Although FERC regulates interstate pipelines, they still need to get permits from PA DEP: find out what DEP air, water quality or other permits the pipeline needs, monitor the permit applications and file comments about how the pipeline will impact clean air and water.
10. Urge your municipality and county

continued on page 16

a foolish trade-off

by Phillip J. Stober

“The history of every nation, is eventually written in the way in which it cares for its soil.”

- Franklin Delano Roosevelt

Energy companies propose crisscrossing Pennsylvania with hundreds of miles of pipelines, destroying the soil in some of the richest farmland in the world – Lebanon and Lancaster counties.

It takes 500 years for the natural world to produce one inch of topsoil, a bulldozer 10 minutes to scrape it away, and an oil spill, about 10 seconds, to render it unfit for food production. In the context of this frantic search for energy reserves and in light of what is happening within our national food system, we need to have a conversation about food and the environment -- two issues inextricably linked -- NOW.

Why? Because California, specifically the San Joaquin Valley, provides over 50 percent of the nation’s fruit, nuts and vegetables, largely on 8+ million acres of irrigated land. Beset by the effects of climate change, including reduced snowfall in the Sierra Nevada mountain range, and historically low outflows from the Colorado and Sacramento/San Joaquin River systems, the long-term prospects for California, as the produce basket for the rest of America, are dim.

If the water shortage continues, California will be out of the national food production business, within a decade. All that irrigated water arrives where it

needs to, because of a network of antiquated aqueducts, constructed along the San Andreas Fault. If there should be an earthquake along that fault – a possibility experts emphasize – California will be out of the food production business the next day.

Why is this so urgent? Because there doesn’t seem to be ANYONE in government, at any level, pondering a future when California can no longer produce 50 percent of our nation’s food supply and the fertile soil everywhere else has been poisoned by the carcinogens of oil and gas wells and hundreds of miles of pipeline.

Who is going to feed the people of Pennsylvania, when Lebanon and Lancaster County, with arguably some of the finest non-irrigated farm land in the world, can no longer raise healthy animals, or grow nutritious fruit and vegetables?

We are in danger of destroying our environment and

selling our children’s future, to the 21st century version of the carpetbagger.

Phillip J. Stober operates Bare Foot Organics at Greystone Farm in West Cornwall Township. He is a USDA Certified Organic farmer, whose very livelihood is going to be impacted by the pipelines planned for Pennsylvania.

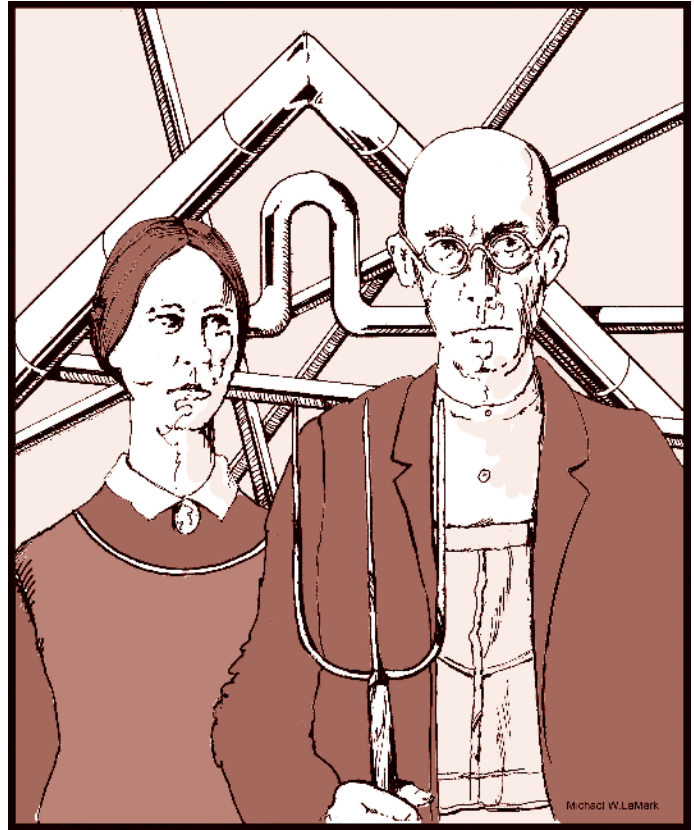

Michael LaMark recalls Grant Woods as he visualizes Pennsylvania Gothic with the homestead being overwhelmed by pipelines.

[pipelineinvasion]

sunoco plans a pipeline stretching across southern pennsylvania

by Pam Bishop

Sunoco Logistics has been holding informational “open house” style meetings in communities across the lower half of Pennsylvania for affected landowners, municipal officials and others interested in the company’s 350-mile Mariner East 2 Natural Gas Liquids (NGLs) Pipeline project. The company announced the \$2.5 billion Mariner 2 project last year.

Sunoco is proposing to build the Mariner East 2 Pipeline, a new 24-inch underground line, to run mostly parallel to the company’s existing 350-mile Mariner East 1’s 8-inch pipeline. Mariner 2 will have the capacity to transport an additional 275,000 barrels per day of natural gas liquids (NGLs) (ethane, propane and butane). NGLs are odorless, tasteless and colorless and highly explosive.

Sunoco currently is engaged in “repurposing” its existing Mariner 1 line -- built originally in 1931 to ship gasoline from the company’s refinery in Marcus Hook to western PA -- by reversing the flow in the 84-year-old pipeline and converting it to transport up to 70,000 barrels per day of NGLs (also called “wet gas”) from the Marcellus Shale region in western PA to the company’s Marcus Hook distribution facility along the Delaware River, near Philadelphia. Mariner 2 will add an estimated four-fold increase to Sunoco’s NGL pipeline transportation capabilities in Pennsylvania.

According to Sunoco, the Mariner East 1 pipeline was “put into service” in December 2014 to carry propane for domestic and international markets. However, Mariner 1 is not currently operating at full capacity because Sunoco has either

not yet built or not yet obtained the necessary municipal zoning approvals and Department of Environmental Protection’s (DEP) air quality operating permits for some of its planned 18 new pump stations and flare stacks. These facilities are needed to pressurize the NGLs for transport through the pipeline and to vent excess gas for operational and safety reasons. There has been some stiff local opposition to Mariner 1 and 2, from residents concerned about safety and environmental impacts, and from local governments and others concerned about Sunoco’s attempts to circumvent local zoning.

Having received 500 requests, DEP held a public hearing in West Cornwall Township (WCT), Lebanon County, on February 17, concerning a proposed air quality operating permit for the “Cornwall Pump Station” in that township. Twenty Cumberland County residents also recently filed an appeal with the Environmental Hearing Board concerning the DEP-issued air quality permit for Sunoco’s Mechanicsburg (Hampden Township) pump station.

A public hearing has been set for April 7, at 7 pm at the Quentin Fire Hall in WCT, by the WCT Zoning Hearing Board regarding a zoning appeal of the construction and zoning permits issued to Sunoco for the Cornwall Pump Station. The appeal, filed by three West Cornwall residents and Concerned Citizens of Lebanon County, alleged the permits were issued in violation of the WCT zoning ordinance and PA Constitution’s Environmental Rights Amendment.

Sunoco recently withdrew its 31 separate requests to the PA Public Utility Com-

mission filed a year ago for exemption from local municipal zoning for 18 pump stations and 17 valve control stations, saying they have and will continue to work with local officials to gain the necessary approvals for the facilities connected with Mariner East 1.

Sunoco officials have said they expect to be able to transport ethane in Mariner East 1 by mid-year, once they finish work on the new pump stations. Ethane will be sold almost entirely overseas. Mariner 2 is expected to be completed by the end of 2016.

In many cases, Sunoco can use Mariner East 1’s existing easements for Mariner 2. In other cases, Sunoco must negotiate with landowners for additional rights-of-way to accommodate the new Mariner 2 pipeline, and quite possibly other pipelines in the future to carry more NGLs to markets, primarily overseas, according to company officials.

Sunoco has said it will use electronic equipment at its unmanned pump stations to monitor the pressure and flow rates of product moving through the pipelines, from its Sinking Springs, Berks County, operational facility. The company has mostly manual and some remotely operated shut-off valves along the Mariner East 1 pipeline for use in an emergency. Sunoco will not be adding to Mariner 1 or 2 mercaptans, the odor-producing chemicals usually used in natural gas lines to alert passers-by of a potential leak.

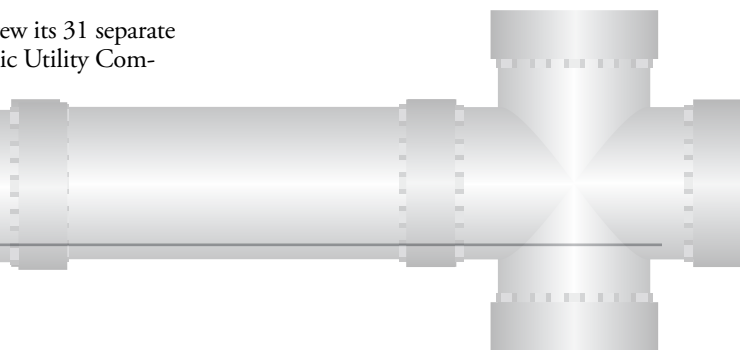

proposed pipeline bisects significant native american sites

by Darvin L Martin

The Oklahoma-based gas pipeline company known as Williams Partners (WMB) has developed plans to construct a new pipeline from the Marcellus Shale region of Northern Pennsylvania south through hundreds of private residences to connect to the Transco Pipeline in Drumore Township, Lancaster County, Pennsylvania. The new construction, known as the Atlantic Sunrise Pipeline, will bulldoze over some of the most culturally significant Native American sites in Pennsylvania, tracing back to the colonial period over 250 years ago. Even though many of the sites are registered with the Pennsylvania Historical and Museum Commission (PHMC) that in itself, apparently does not protect the sites from a corporate power using eminent domain.

Through the years, almost all evidence of the Native people who used to live in Lancaster County has been destroyed. This pipeline project would complete the destruction by erasing the final piece of history. This land deserves to be protected from this encroaching threat. If the full cost of environmental, historical and cultural degradation were assessed, Williams simply would not be able to afford the project what it has planned.

Pennsylvania once housed a powerful nation, an Iroquoian-speaking people, known by those to the south as the Susquehannocks and by those to the east as the Minqua. These people inhabited the full length of the Susque-

hanna River during the 1600s, and established a centralized government and trading authority in what is now Manor Township, Lancaster County. Here they grew into a force that challenged the Colony of Maryland for decades before William Penn settled Philadelphia. They constructed several great fortified population centers just inland from the Susquehanna. Three we know by name—the great towns of Sasquehannough and Conewaga, each inhabited by over two thousand people, and a later site known as Conestoga Indiantown, a remnant of a tribe impacted by over a century of colonialism.

Decimated by war and disease, the once great Susquehannock nation was in ruins by the 1690s. When William Penn sought their friendship in 1701, only a group of 200 to 300 remained in what is now Lancaster County, using the great Manor lands as their hunting grounds and living about four miles inland from the river, along what is now Indian Marker Road, next to an ancient Indian mound colloquially named Chief's Hill. This village, known as Conestoga Indiantown, lies straight in the development path of the recently proposed pipeline.

Penn, based on his own understandings of the boundaries of his land grant, reserved 16,000 acres, allowing space for this tribe, excluding this area from European settlement. He defined the land as his own "manor," the very hunting grounds for this special remnant of Susquehannocks, now known by their

own name—the Conestogas. After Penn's death in 1718, the Philadelphia government at first honored his wishes to keep to land closed to settlement. However by 1737, Penn's sons succumbed to increasing pressure and offered such prime farmland to both German and English settlers. Conestoga Indiantown was reduced to 414 acres, and fenced, becoming the first example of an effective Indian reservation in the Americas.

During the period of 1701 to 1763, Conestoga Indiantown hosted scores of negotiations and treaties between colonists and natives. For decades it became a focal point where western and native cultures could meet under the umbrella of peace. It was a reference point for maps and geography, and a transition point for Native Americans moving west deeper into the frontier. The prime Native lands, including the ruins of forts and settlements along the Susquehanna, and Conestoga Indiantown itself, remained closed to European occupation until well after the last Native inhabitants of Conestoga were brutally massacred by Scots-Irish vigilantes in December 1763. After a holding time, in the 1780s the Philadelphia government sold the lands to real estate speculators, who in turn profited by turning cultural sites into new farms for an expanding Pennsylvania population.

Under private ownership, many of the artifacts within the once grandiose town of Sasquehannough were dug up and absorbed into personal collections. Graves were desecrated through digging the foundations of new buildings to create a new town called Washington Borough. However both Conewaga and Conestoga

[pipelineinvasion]

native american

continued from previous page

Indiantown remain as farms, amazingly largely undisturbed by development projects until now.

Have we learned nothing from history?

Our industrial world follows a ghostly inclination, largely unconscious to the public, but purposefully driven by those who have the money and power to collect immediate benefits. Seemingly by default, we continue to assert the most highly destructive technology as superior,

even when we later acknowledge it as inappropriate. We subject the environment to our will, attempting to conquer, dominate, and control that which we don't understand and which challenges our sense of power and authority.

Our exploitation of this Native community stripped the land of furs, and later logs, and still later into the modern era—oil, coal and natural gas—all taken far away, without local benefit. In return Natives were given glass beads, small

metal objects such as bells, pins, and decorative pieces, and coins. As demand increased, the natural spoils were traded for iron hatchets, guns and ammunition. Step forward to today and our natural resources are still squandered cheaply, and local residents are left with empty promises. As demand increases, we can expect Williams Partners to offer stronger incentives to pacify local communities.

your landowner rights

continued from page 12

to intervene in the FERC process and to file comments about how they want the pipeline to avoid impacts on your community -- while the pipeline does not have to abide by local zoning laws, FERC takes municipal and county comments seriously and often requires the pipeline to comply with municipal concerns.

11. If FERC or PUC does approve the pipeline through your land, retain an attorney to negotiate the Natural Gas Pipeline Easement Agreement. Everything in that agreement is negotiable (For example: "price per linear foot" to you, the type and location of pipeline facilities, pipeline depth and width, construction rules, timetable, how you can use the easement, restoration after construction, liability, etc.).

Don't negotiate with the pipeline company by yourself. Get a lawyer.

Note: To find an attorney who specializes in rights of way, contact the county Bar Association's Lawyer Referral Service or contact one of the citizens' groups that are opposing the pipeline in your area.

pipeline heartburn

continued from page 7

diameter of the pipe, the pressure and the product the pipeline is carrying. Advocates believe that people have a right to know if they are living within the PIR.

In most instances, the amount of regulation and inspection of pipelines is determined by how many people live nearby. The more dense the population, the more regulated the pipeline.

Pipeline companies have inspection programs, using a combination of automated, aerial, and on-the-ground inspections. However, according to the Leak Detection Study, commissioned by PHMSA, members of the public are more likely to detect pipeline leaks than inspectors. In fact, out of all the methods used to monitor pipelines for leaks, the most common way leaks are found is by a member of the public. Based on the report,

automated and computerized leak detection systems only detected leaks 17 percent of the time.

Citizens are baffled by a confusing set of laws that parcel out responsibilities among state and federal agencies. Which agency does what depends on what the pipeline is carrying, whether the pipeline crosses state lines, whether the pipeline serves customers directly and whether the pipeline goes through areas that deserve special protections, like wetland or habitats for endangered species. The Federal Energy Regulatory Commission, the U.S. Department of Transportation's PHMSA, the Pennsylvania Public Utility Commission, the PA Department of Environmental Protection, and even the Pennsylvania Historical and Museum Commission may have special duties for siting or regulating pipelines.

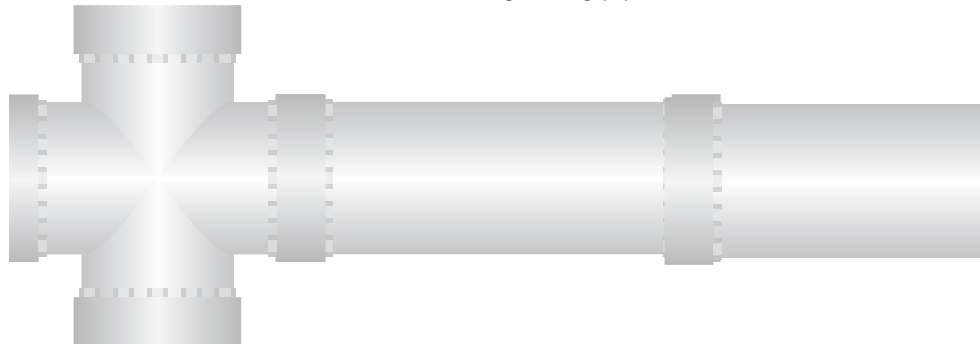

[explore enjoy...pennsylvania]

the golden eagle trail has it all

by Gary Thornbloom

After nine miles and five hours I agreed: the Golden Eagle Trail has it all - mountain streams, waterfalls, sculpted rock outcroppings, intimate hollows, glimpses of the past use of what are now Public Lands, and magnificent panoramic views.

The trailhead is 3.8 miles north of Cammal on Route 414 in Lycoming County. We immediately began climbing out of Pine Creek Gorge, following Bonnell Run north on the entrance trail.

We chose to climb early in the hike, and to end the hike on a long downhill stretch. We turned south as the entrance trail joined the main trail and climbed the divide between Bonnell and Wolf Runs following the Golden Eagle Trail counterclockwise.

After a quarter mile the trail follows a relatively wide bench across the side of the divide. Here, Clark's pasture is being gradually reclaimed by its rightful owners - white pine trees. Along the trail are two invasive plants that often follow human activity - Asian bush honeysuckle and barberry. You also come to the first of many views. Here you look across, as well as down, Pine Creek.

The grade increases, gaining 800 feet in less than a mile.

As the trail follows the contour across the sidehill there is an excellent view to the left of the trail that looks into Wolf Run. This view would be the highlight of many hikes, but as you continue following the narrow ridge that juts out above Pine Creek Gorge and Wolf Run the next view is a breathtaking panorama that looks into and over the area. This is Raven's Horn, a traditional roosting spot for ravens and an interesting, impressive rock formation, as well as nice habitat for rattlesnakes.

Along the narrow ridge the geology now

dominates. Rock - layered, carved, crannied, slightly folded, spired, undercut - then loose rock underfoot, the trail drops, and you are walking along the exposed ridge spine. Ferns and lichens are tucked into exquisite rock gardens.

The trail turns away from Pine Creek and descends into Wolf Run. Bear left and continue climbing down the slope and up Wolf Run.

Wolf Run is a narrow hollow. There was not much water flowing, just a trickle between rocks, bare stretches with leaves, and still pools. With more water there would be small waterfalls. Rock, outcroppings and layers, sandstone and shale, maintained our interest.

The hollow closes in. Huge blocks of stone lay tilted. Water snakes through the jumbled rock. At an old quarry site sheets of flagstone stand on end along the rock wall. In another half mile there is a notable rock outcropping above Watson Fork. Wolf Rock, after a steep climb, provides more views up and down Wolf Run.

Climbing out of Wolf Run we find many hemlocks, giant hemlocks as well as dog hair thickets of hemlock. Loggers had spared these hemlocks. Beauty? Shelter? Clean water? Chunks of an old stove indicate a logging camp once stood in this area.

continued on next page



This photo of Raven's Horn taken by Bill Mertens looks into and over the area that includes Wolf Run and Pine Creek Gorge.

explore, enjoy, pennsylvania

continued from previous page

As the trail enters State Game Lands the grade eases and there is yet another vista that overlooks the west side of Pine Creek as well as terrain threaded by the Black Forest Trail.

We eat lunch at the next vista, Beulahland, a vista that includes forests, fields and ridges that recede into Tioga County. Back on the trail we soon look down Bonnell Run at one last vista.

The final 3.25 miles are downhill. The hollow begins dry, but soon includes a small stream. The green of hemlocks and Christmas fern brightens the hollow. Evergreen leaves of Christmas fern hold not only a slight dusting of snow but also fallen deciduous leaves trapped by prior year's fronds. Trapped leaves, one small way in which nature stabilizes the steep mountainside.

The Golden Eagle Trail has it all, and will reward those willing to spend a strenuous day exploring and enjoying.

Did You Know?

When you see one of these icons in an email or post, you can easily click on them to post to your own account. A great way to spread the word to your network.



“We shall achieve conservation when and only when the destructive use of land becomes unethical—punishable by social ostracism.”

Aldo Leopold

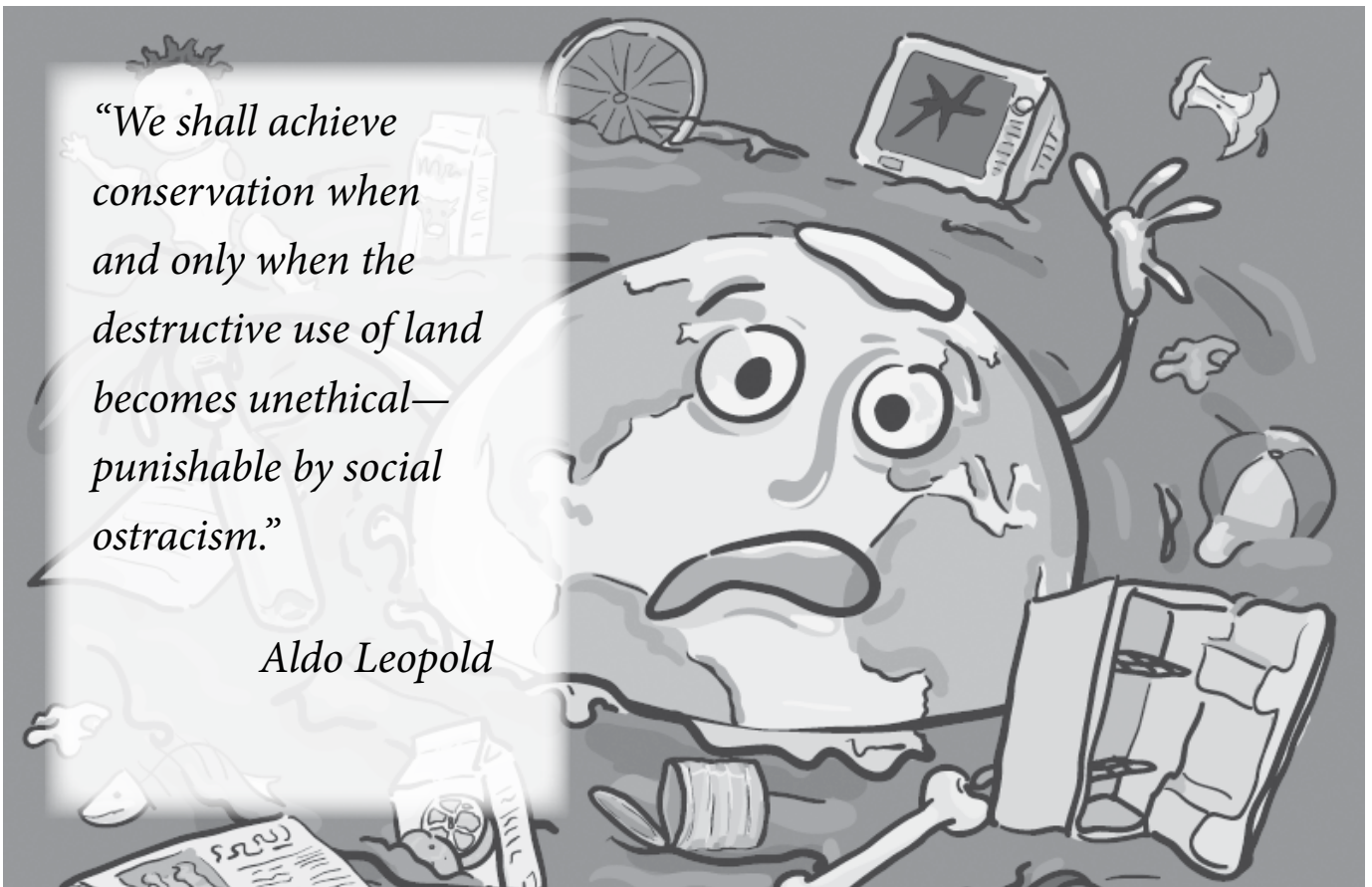

meet the PA chapter's new diversity chair, sue edwards

In January when the Pennsylvania Chapter Chair Wendi Taylor asked if I would be willing to serve as Pennsylvania's first Diversity Chair, of course, I immediately said, "Yes!"

For too long the Sierra Club has reached out to people who belong to other environmental groups, whose members already think like us. Since the big environmental issues of our time affect all kinds of people, it is time to reach out to all kinds of groups and all sorts of people, explained Taylor. "To do this, we may need some guidance from someone who had experience with working with diverse groups," she told me.

Taylor knew about the work I had done as part of the Philadelphia Beyond Coal Campaign team of volunteers, which reached out to non-traditional allies. She knew how passionate I am about broadening our base and confronting environmental racism.

The Sierra Club national board is in the midst of a concerted effort to build Diversity, Equity and Inclusion (DEI) into every aspect of the organization's work.

Late last year, a group of about a dozen volunteers and staff from around the state took part in DEI training, led by national board member Allison Chin and Pittsburgh Beyond Coal organizer Randy Francisco. This helped to get us started.

My job as Diversity Chair is to be a resource for the chapter and groups in learning how to be more welcoming to peo-

ple from a variety of backgrounds and how to be sensitive to people and respectful of many cultures. We will need to be receptive to new ways of doing things and to be ready to meet people where they are.

My vision is for the Sierra Club to lead the way within the environmental movement in becoming diverse in race, class, age, sexual orientation, faith, and more. To work for environmental justice (EJ), we need EJ voices to play a leading role.

Among other things, I'll be encouraging Sierra Club groups to work toward becoming more diverse to more closely reflect the makeup of their communities, assisting groups to resolve issues that may arise as they undertake this work. I will also reach out to organizations and groups representing diverse constituencies to find common ground and explore potential collaboration.

One of my first undertakings is to join several other Sierra Club staffers and volunteers from Pennsylvania and attend the White Privilege Conference being held in Louisville, KY, in March 2015.

I welcome questions, comments, and suggestions from anyone involved with Sierra Club around PA. As the mantra of the People's Climate March in Sept. 2014 in New York City went: "To change everything, it takes everyone!"

answers to crossword puzzle

(from page 24)

Across

- 1 Edwards
- 3 Pillar
- 5 Conewaga
- 7 Huplits
- 9 Utility
- 10 Higgs
- 11 Quigley
- 13 Safety

Down

- 2 Regulatory
- 4 impact
- 5 Creek
- 6 Eagle
- 8 Sunrise
- 12 Gas

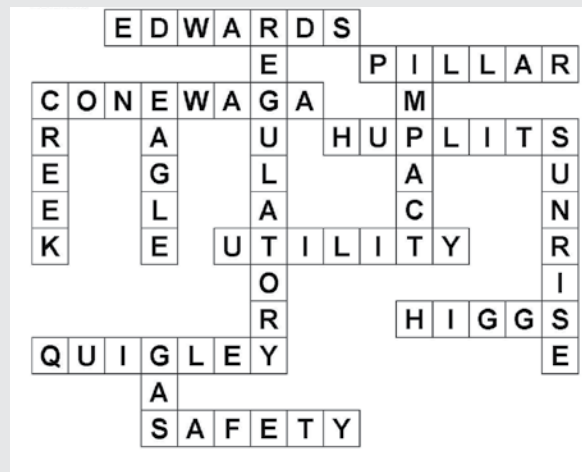

coal mining continues to scar pennsylvania

by Joanne Kilgour

While the media often report about fracking, they rarely report on the harsh and ongoing realities of underground mining. However, longwall and room-and-pillar mining continue to scar Southwestern Pennsylvania and particularly impact the communities of Washington and Greene Counties.

At the end of 2014, the Department of Environmental Protection released the fourth Act 54 Report on the impacts from underground mining in Pennsylvania between the years of 2008 and 2013, but it was not the kind of story that made the evening news.

Based on this 4th assessment, it is clear that the state must act to better protect our communities, freshwater resources, and economy from the impacts of underground mining. This report reveals alarming gaps in policy and implementation of the law, and describes a regulatory system that allows the widespread destruction of homes, streams, and aquatic life.

The Sierra Club -- along with Tri-State Citizens Mining Network, now the Center for Coalfield Justice -- has long been concerned about underground mining, especially the inadequacy of the law to deal with water loss and water replacement, damage to surface structures, and impact to surface waters.

According to the Act 54 Report, the Bituminous Underground Mining Information System (BUMIS) recorded 855 effects on wells, springs, and ponds -- 57 percent of which the mine operator was found liable for with a final resolution. Of that 57 percent, one quarter occurred outside of the Department's Rebuttable Presumption

Zone, indicating that the rebuttable presumption zone does not adequately reflect the true area in which residents can expect to see impacts to their water supply. In cases where the mine operator was found liable, resolution was delayed for over one year (415 days)! Residents were left without an adequate water supply for a burdensome amount of time, even where the mine operator was determined to be at fault.

Drinking water and water used for household purposes is one of the essential elements of a healthy community. The Department must employ practices that will restore an adequate water supply to impacted families in a more timely manner.

In addition to impacts to water supplies, the report outlines impacts on streams and freshwater resources. According to the report, 96 miles of stream were undermined, 40 percent of which experienced mining-induced flow loss or pooling. With 39 out of 96 stream miles undermined experiencing flow loss, impacts to streams from underground mining remain an area of significant concern and must be addressed. The report indicates that both mining-induced-flow loss and pooling constitute adverse effects to macro-invertebrates, with certain mayfly taxa especially hard hit.

Further, the report indicates that mining-induced flow loss results in a decline in water quality, including increases in conductivity and pH. The report also notes that because the information system was not designed to track the complexity of stream impacts, DEP has failed to record adequate stream data. This is an area that DEP must improve.

The report also states that "following up on streams that were impacted during the 3rd Act 54 assessment, 51 of the 55 stream investigations from that period have been resolved. For eight of the resolved investigations (involving seven streams), DEP indicates that the streams have not recovered from the mining-induced impacts" (emphasis added). This means that nearly 16 percent of streams impacted by mining are not recovering.

The report also states that undermining at three longwall mines resulted in a substantial loss of original wetland acreage and creation of new wetland acreage. This new wetland acreage often differs in functionality and thus the newly emerging and created wetlands do not adequately replace lost wetland functions. For the one mine that exhibited a net decrease in wetland acreage, two wetland mitigation projects have been proposed. However, the report recognizes that proposed projects will not fully replace the function of the lost wetland acreage.

The Sierra Club will join the Center for Coalfield Justice in submitting more technical written comments on this report, and we will continue to highlight the unacceptable consequences of this form of extreme extraction. Particularly concerning are the findings of this report on the impacts to water supplies and our freshwater resources.

To learn more about the impacts that the people in southwestern Pennsylvania are living with every day as a result of underground mining, read the 4th Act 54 Report, available at the link below. http://www.portal.state.pa.us/portal/server.pt/community/act_54/20876.

chapter accepting applications for wyona coleman scholarship

It's Spring! That means it's time to apply for the Wyona Coleman Scholarship. The Pennsylvania Chapter of the Sierra Club awards one or two \$1,000 scholarships each year in honor of Wyona Coleman.

The scholarship is open to all Pennsylvania residents who are seniors in high school, in addition to those already accepted or enrolled in college.

The Wyona Coleman Scholarship Fund is a memorial to Sierra Club member Wyona Coleman, who was a founding member of both her local group and the Pennsylvania Chapter. Coleman was a longtime champion of coalfield residents victimized by unregulated strip mining, and was so instrumental in advocating for the Surface Mining Control and Reclamation Act, that she was invited to the White House to wit-

ness President Jimmy Carter sign the bill into law.

Applications must include a letter of application, the student's academic record, two letters of support -- at least one from a community group in which the applicant has done volunteer work, and a 300-word essay on how the student intends use his or her education to protect the environment. The letter of application should include some basic biographical information about the student and attest to the student's financial need. Each essay must include a heading with the applicant's name, home mailing address, email, and phone number.

Applicants will be evaluated on academic potential and financial need.

Those awarded the scholarship will be required to provide their Social



Security Numbers and the name and address of the institution they will be attending.

Applications are due June 30, 2015, and should be submitted electronically to:

pennsylvania.chapter@sierraclub.org
Please place the word "Scholarship" in the subject line. The scholarships will be awarded July 15, 2015.

the 18th annual huplits wildlife grant competition: a challenge to protect animal wildlife and habitat in pennsylvania

The Allegheny Group Sierra Club's Huplits Wildlife Grants Committee is seeking grant

proposals to help protect animal wildlife and wildlife habitat in Pennsylvania.

Approximately \$50,000.00-\$60,000.00 will be available for the 2015 Huplits Wildlife

Grant Competition. Six (6) grants were awarded in last year's (2014) competition, totaling \$45,000.00.

APPLICATION GUIDELINES:

- We seek projects that directly impact wildlife in the Commonwealth of

Pennsylvania on a regional or state-wide level.

- A proposal may involve public education, grassroots campaign organization, litigation, land acquisition, or research that directly focuses on protecting Pennsylvania wildlife, its habitat, and preventing cruelty to animals.
- Projects will be funded for no more than two years. Under special circumstances a project may be extended.
- Grants may be sought by Sierra Club entities within Pennsylvania.
- Grants may also be applied for by non-Sierra Club organizations in

Pennsylvania, although preference will be given to such organizations if the proposed project is in partnership with Sierra Club members.

A proposal should include the overall purpose and goal of the project, objectives, major activities, resources required, specific timelines, and a detailed budget.

DEADLINE: Submit proposals no later than May 4th, 2015 to Ed Chute (Huplits 2015 Committee Chair) via e-mail at alg.huplits@gmail.com. If you have any questions, contact Ed via email or call 724.516-7751.

clean river campaign

by Tom Hoffman

Over the past months, the Sierra Club and the Clean Rivers Campaign have been talking to thousands of ratepayers to educate them about skyrocketing rates at ALCOSAN (Allegheny County Sanitary Authority). In order to help low- and fixed-income individuals and families continue to afford water and sewer services, **the campaign gathered over 2,500 signatures** to support a Customer Assistance Program (CAP).

On Thursday March 26, Sierra Clubbers, other campaign allies and ratepayers took this message to ALCOSAN. **We held a press event outside of the ALCOSAN gates and then took the thousands of signatures into the board meeting.** An Action United member presented them to John

Weinstein, the Chair of the ALCOSAN Board.

Ten minutes later, in the New Business section of the meeting, **Chairman Weinstein made a motion to create a sub-committee of the Board to develop a Customer Assistance Program.** It passed UNANIMOUSLY.

This is a significant victory for ratepayers across the region and wouldn't have happened without the support of Sierra Club and the other organizations in the Clean Rivers Campaign. We now need to make sure that the Board lives up to this important promise.



Even with this victory today, we will not stop fighting. The Clean Rivers Campaign will continue to work with ratepayers across the region until a customer assistance program is a reality. We will also continue to fight for a green first plan for fixing the sewage in the rivers problem.

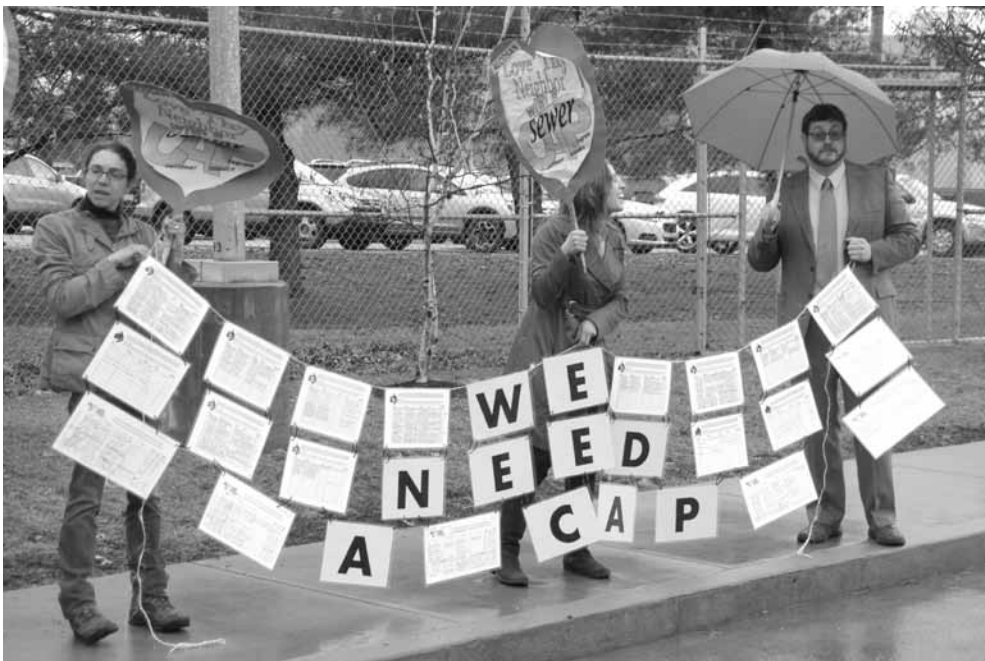

[meetings and outings]

Meetings and Outings

For up-to-date information, please see the websites listed below.

Chapter Executive Committee

<http://pennsylvania.sierraclub.org/>

Follow us on Facebook: <http://www.facebook.com/PASierraClub>

Follow us on Twitter: @Sierra-ClubPA

Allegheny Group

www.alleghenysc.org

Governor Pinchot Group

<http://pennsylvania.sierraclub.org/Pinchot>

Kittatinny Group

<http://pennsylvania.sierraclub.org/kit/>

Follow us on Facebook: <https://www.facebook.com/Sierra.Kitt.Club>

Lake Erie Group

www.lakeeriegrouppa.org

Lancaster Group

www.lancastersierraclub.org
Follow us on Facebook:

<https://www.facebook.com/sierraclublancaster>

Email: sierraclublancaster@yahoo.com

Lehigh Valley Group

<http://sierraclublv.wordpress.com/>

Follow us on Facebook: <http://www.facebook.com/sierraclublv>

Moshannon Group

www.sierramsh.org

Follow us on Facebook: <http://www.facebook.com/#!/groups/112180198821601/>

<http://pennsylvania.sierraclub.org/moshannon/outings.html>

Northeastern Group

<http://pennsylvania.sierraclub.org/northeastern>

Otzinachson Group

<http://otzinachson.wordpress.com>

Follow us on Facebook: (<https://www.facebook.com/Otzinachson?ref=ts&fref=ts>)

Southeastern Group

<http://pennsylvania.sierraclub.org/southeastern>



With your help we can clean up our water

Sierra Club Water Sentinels are the first line of defense of America's waters. We live on the water planet. However, water is a finite resource with only about 1 % of the world's water actually being available for human consumption. Water pollution & over-use are threatening both the quality & quantity of our water resources at an alarming rate.

Keep our water safe. Join Sierra Club.

Name _____
 Address _____
 City _____ State _____ Zip _____
 Phone _____
 Email _____

Check enclosed. Please make payable to Sierra Club

Please charge my: Visa Mastercard AMEX

Cardholder Name _____

Card Number _____ Exp. Date ____ / ____

Signature _____

Membership Categories	Individual	Joint
Special Offer	<input type="checkbox"/> \$ 15	N/A
Standard	<input type="checkbox"/> \$ 39	<input type="checkbox"/> \$ 49
Supporting	<input type="checkbox"/> \$ 75	<input type="checkbox"/> \$ 100
Contributing	<input type="checkbox"/> \$ 150	<input type="checkbox"/> \$ 175
Life	<input type="checkbox"/> \$ 1000	<input type="checkbox"/> \$ 1250
Senior	<input type="checkbox"/> \$ 25	<input type="checkbox"/> \$ 35
Student	<input type="checkbox"/> \$ 25	<input type="checkbox"/> \$ 35
Limited Income	<input type="checkbox"/> \$ 25	<input type="checkbox"/> \$ 35

Join today and receive a FREE Sierra Club Weekender Bag!



Contributions, gifts & dues to Sierra Club are tax deductible; they support our effective, citizen based advocacy and lobbying efforts. Your dues include \$ 7.50 for a subscription to SIERRA magazine and \$ 1.00 for your Chapter newsletter.

F94Q W 1



Enclose a check and mail to:
 Sierra Club, PO Box 421041
 Palm Coast, FL 32142-1041

or visit our website: www.sierraclub.org

NON-PROFIT
US POSTAGE
PAID
HARRISBURG
PA
PERMIT NO.
705



explore, enjoy and protect the planet.

[spring crossword]

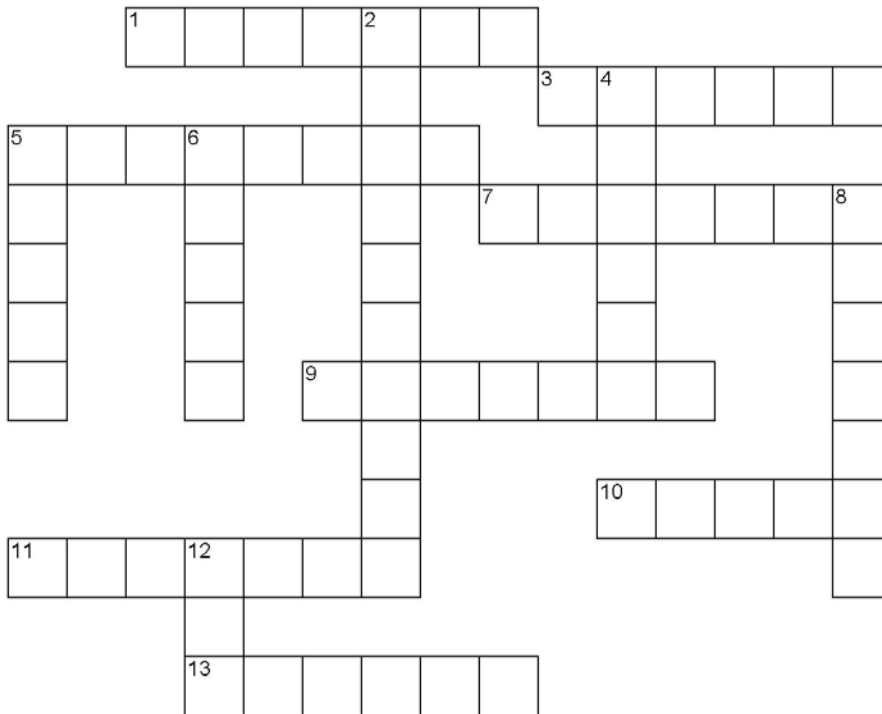

Across

- 1 Diversity Chair
- 3 Room and _____ Mining
- 5 Native American City
- 7 _____ Wildlife Grant
- 9 Pennsylvania _____
Commission
- 10 _____ Boson
- 11 Secretary of DEP
- 13 Pipeline _____
Coalition

Down

- 2 Federal Energy _____
Commission
- 4 Potential _____ Radius
- 5 Pine _____ Gorge
- 6 Golden _____ Trail
- 8 Atlantic _____ Project
- 12 Beyond Natural ____
Campaign

answers on page 19